

sinbad
engineering corp

Weatherly Wireless Timing System Installation

June 12, 2012

Summary

For the Weatherly PHA Hillclimb course, the start line is in a “bowl”, and significant elevation is needed to communicate with the finish line from the start line (ex: we did not have success at 75 feet). So, the ideal location for Z T-Link antenna is located at the intersection of Evergreen Ave and North Street. Communication between the Z T-Link and Timing PC can be achieved at this location using wireless RS232 units – no cable runs are necessary.

The B T-Link antenna is placed at the finish line, and the A T-Link antenna is placed at the start line. Neither unit is placed far enough away from the sensors to require a long cable run.

NOTE: Weatherly is currently working on a permanent setup. As of June 2012, a permanent pole was placed at the finish line that is 40 feet above ground and has a 10 foot extension. A bracket will be permanently installed on this pole to allow for the easy installation of the antenna and cable for each event (no alignment should be necessary).

The start line pole is still in work – we attempted to use the sign at the start line, but did not have good enough signal (signal strength was averaging below 50 percent with occasional drops to zero). We are working on a different location for the fall 2012 event.

Antenna Setup Detail

B T-Link	Antenna Type	Yagi
	Location	At road right after finish line (finish worker station)
	Height	2012: Permanent pole across from finish line that is 40 feet above ground with a 10 foot extension. 2011: Mast raised to 43 feet (previously had success at 20 feet, with note that more elevation would be better) Note – would be better to move base further back towards gate so that there is a better angle on the guy lines.
	Direction	2012: 155° (magnetic), minimum vertical angle down 2011: 160° (magnetic), minimum vertical angle down
Z T-Link	Antenna Type	Yagi
	Location	At intersection of Evergreen Ave (the course) and North Street (where Joe lives), on south west corner.
	Height	Mast raised to 43 feet (previously had success at 40 feet with note that more elevation would be better) Note – for Fall, plan to use permanent pole on North street
	Direction	335° (magnetic), no vertical angle
A T-Link	Antenna Type	Omni
	Location	At start line
	Height	No elevation necessary, omni antenna attached to A T-Link unit, no extender cable necessary
	Direction	N/A

Cable Runs

B T-Link to Finish Sensor	None Needed. The B T-Link unit is positioned a little farther away from the finish line than 25 feet, but the Race America cable can be extended using a Cat 5e cable and RJ45 inline coupler. 2012: Need 50 foot cat 5e cable and RJ45 inline coupler to use with new pole
A T-Link to Start Sensor	None Needed. The A T-Link unit is positioned within 25 feet of the start line, and no additional cable runs are necessary.
Z T-Link to Timing Station	None Needed. We use wireless RS232 transmitters between the Z T-Link and the Timing Station. The antennas for these units need to be elevated as follows (using the RPSMA to RPSMA antenna cables): Z T-Link end: raised as high as can be reached from a step ladder, and attached to the Z T-Link antenna mast Timing Station end: raised above ground level by hanging it from the Timing Station EZ Up frame.

Signal Strength at Previous Events

Spring Weatherly 2012: First event with permanent pole. Start signal strength 100% most of the time. When using start line as location for Z TLink antenna, finish signal strength 20-60% with occasional drops to 0%. When using temporary masts and normal location at Evergreen and North street, finish signal strength 80-100%.

Fall Weatherly 2011: Comparable to Spring 2011, no incidents.

Spring Weatherly 2011: First event with new masts. Start signal strength 100% most of the time, 90% occasionally, very occasional brief drops to ~30%. Finish signal strength 80-100%. Occasional drops to 40-60%, but generally sits at 100%.

Fall Weatherly 2010: Better antenna positioning and elevation gave us signal strength of 60-100%. The wireless system ran in parallel with the wired system for the entire event, and the signal strength remained consistent enough that we could have used the system to time the event.

Spring Weatherly 2010: Signal strength was not good enough to time the event, especially during and after a rain storm. The antennas were not positioned well and were not elevated high enough

Map and Photos

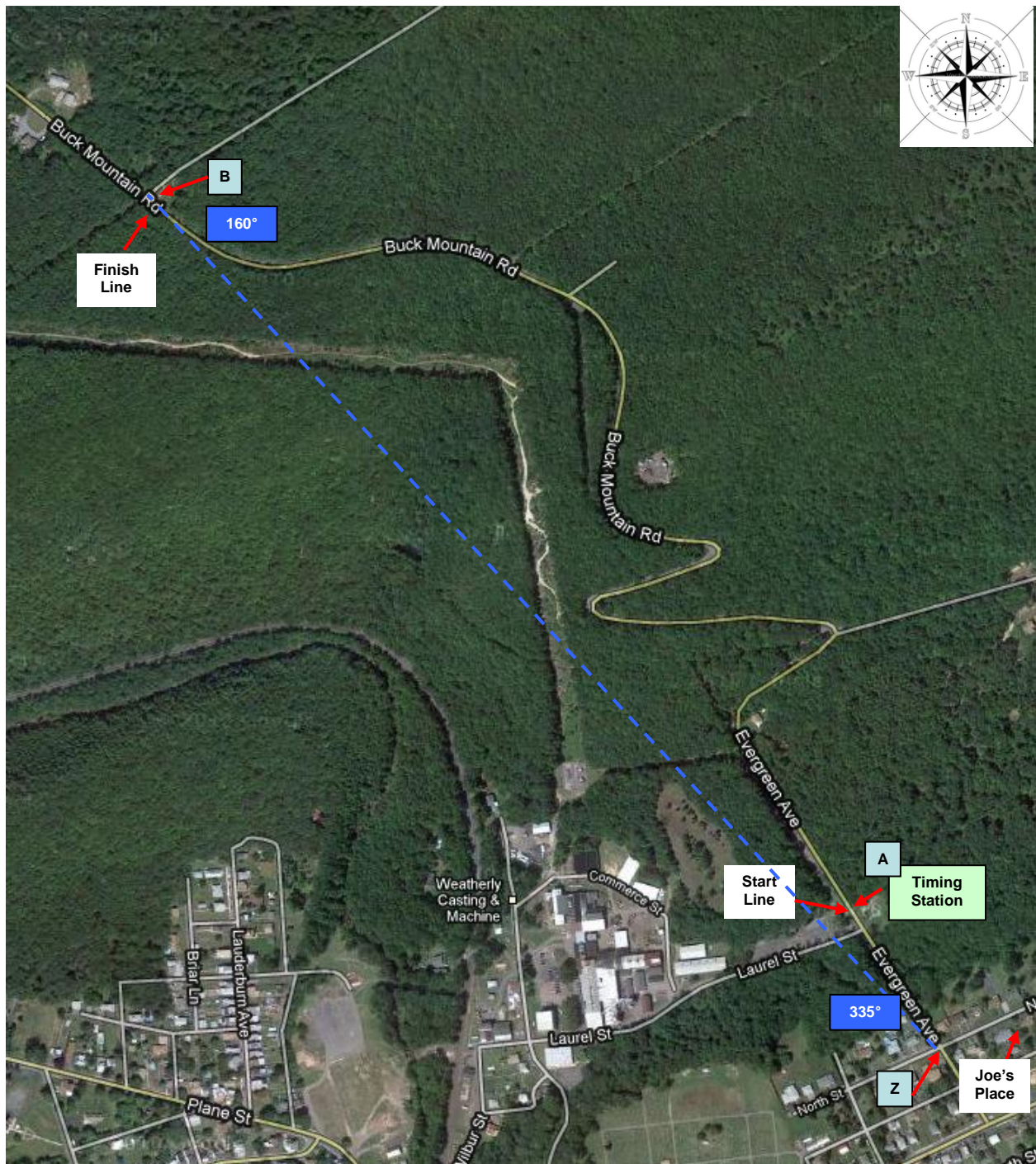

Figure 1: Weatherly Course Map and Wireless Component Locations



Figure 2: Weatherly Z TLink Antenna Mast



Figure 3: Weatherly Z TLink Mast Base and Guy Lines



Figure 4: 2011 Weatherly B TLink Antenna Mast



Figure 5: 2011 Weatherly B TLink Mast Base and Guy Lines

A T-Link to Sensor Cabling

The A T-Link unit is within 25 feet of the sensors, and all that is needed is the Race America Sensor cable.

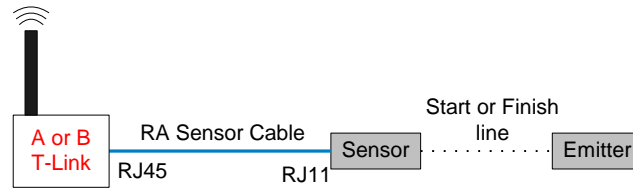

Figure 6: Basic Connection Wiring Diagram

B T-Link to Sensor Cabling

The B T-Link unit is within 100 feet of the sensors, and the RA provided cable can be extended using a Cat 5E cable and a white RJ45 inline coupler to connect the Cat 5E cable to the Race America cable.

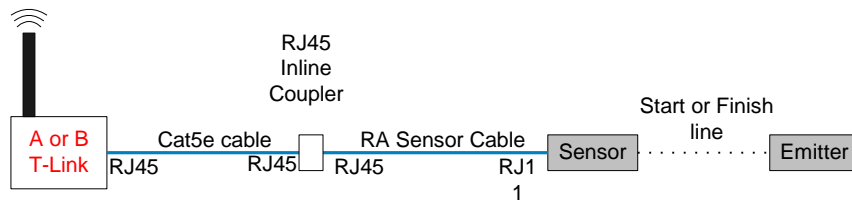

Figure 7: Basic Connection extended 50 feet, Wiring Diagram

NOTE: On the T-Link side, be sure to plug the RJ45 (8 pin) connector into the T-Link unit, and the RJ11 (6 pin) connector into the RJ45 inline coupler.

Z T-Link to Timing Computer Cabling

For Weatherly, wireless RS232 units are used to connect the Z T-Link unit to the computer.

Note on power sources: the wireless RS232 units require a USB power source, which can be supplied via a USB power pack, or using the AC Transformer (if AC power is available). The USB power pack should last the entire event. The main power packs are rechargeable and the spare power packs take 4 AA batteries.

To connect the Z T-Link to the Timing Computer, you will need the following equipment:

- 1 Race America T-Link to Timing PC cable
- 2 SNAP wireless RS232 units and power sources
- 1 DB9M / DB9F null model adapter
- 1 DB9M / DB9M gender changer
- 1 DB9M / DB9F cable

Once the Wireless 232 units are connected as shown in the diagrams below, and powered on, initiate communication between the units as follows:

- On the PC side, press and hold the MODE button on the Wireless RS232 unit for 5 seconds. LED A will flash red
- On the Z T-Link side, press and hold the MODE button down for 5 seconds.
- The units will be paired, and LED A will show a solid green on both units (a solid amber indicates a weak connection).

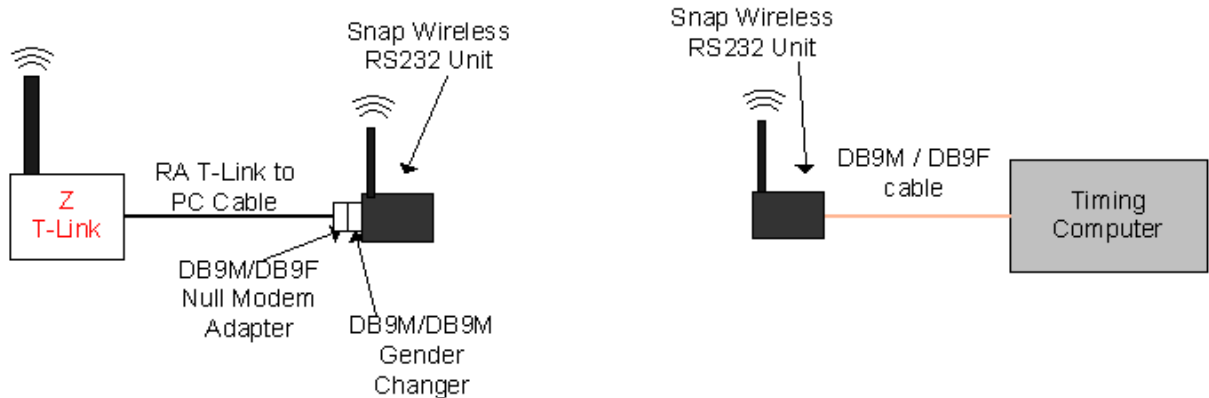

Figure 8: Wireless RS232 Connection, Wiring Diagram

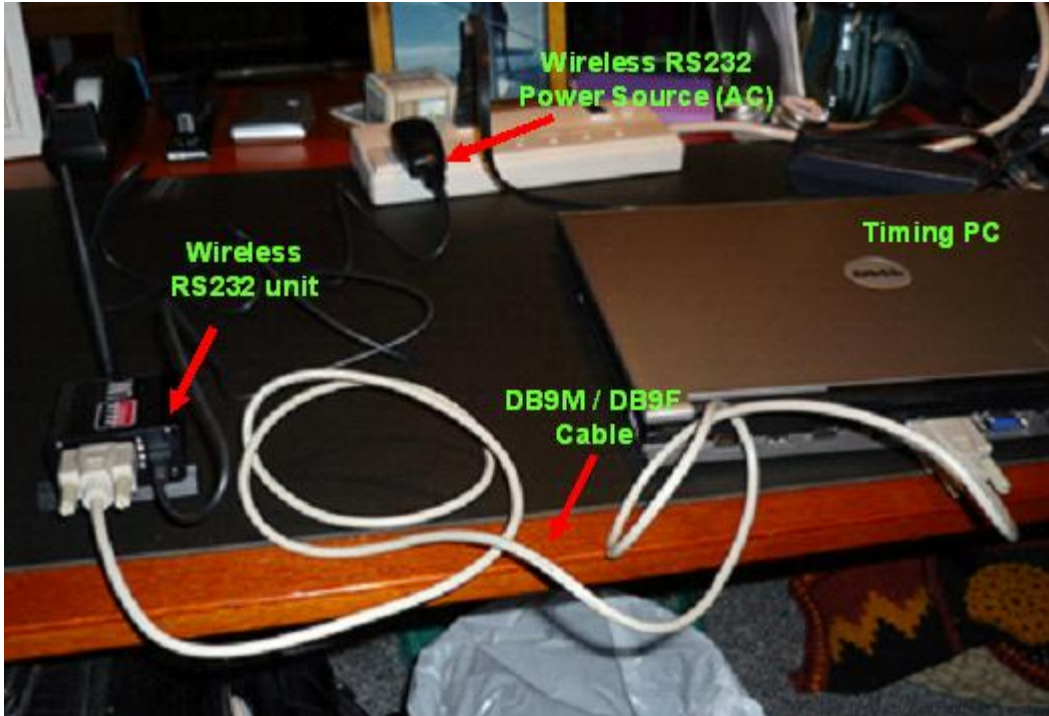

Figure 9: Wireless RS232 Components, Timing PC Side

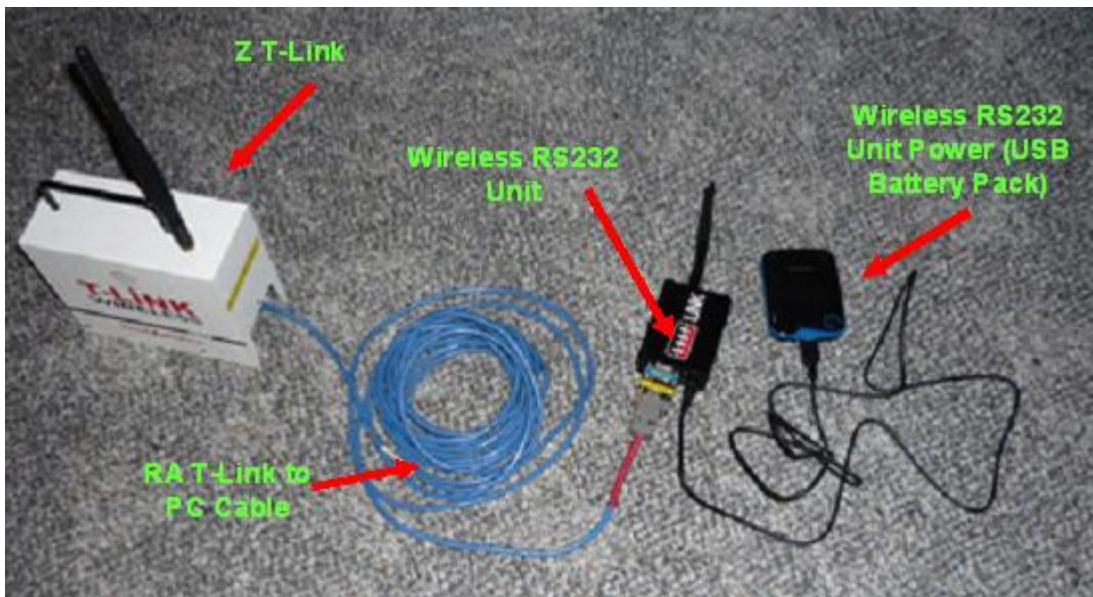
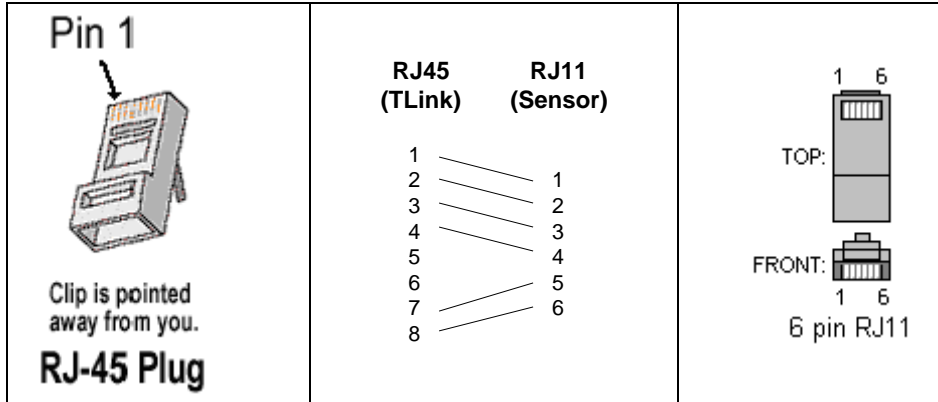

Figure 10: Wireless RS232 Components, Z T-Link Side

Cable Pinouts

This section includes pinouts for the Race America and other custom cables used for this event.

Race America Sensor Cable Pinout



Race America Z T-Link to PC Cable Pinout

